

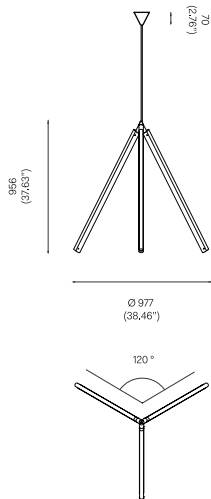

LIT LINES  
PENDANT 1, 2011

Satin Brass.  
Pendant rod length to order.  
Limited edition of 18.

OVERALL DIMENSIONS



BACKPLATE DIMENSIONS

Mounting screws not included  
6mm countersunk screw recommended

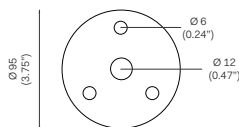

MATERIALS AND FINISHES



Satin Brass

BULB SPECIFICATIONS

Bulb specifications 120V / 240V  
S14s opal LED tube  
Radium Raledina 16.5W / 1000mm Ø 29mm  
1000lm / 2700K

PRODUCT SPECIFICATIONS

Input voltage: 120V / 240V  
Maximum wattage: 16.5W  
Dimmable: yes  
Product weight: 25kg

Pendant rod length to order with maximum  
rod length 2000mm.

Please supply required drop length of fixture,  
measured from the ceiling to bottom fitting  
at time of order.

CLEANING INSTRUCTIONS

Before cleaning, lighting fixtures must  
be turned off and unplugged from mains  
electricity. Whilst cleaning please take care  
and use the gloves provided.

Satin Brass: Use a Scotch Brite pad and gently  
rub the pad in the direction of the grain.  
Repeat until the natural patina is removed.  
On rubbing the Scotch Brite to the brass,  
grains will occur. The colour of the product  
will temporarily get lighter until it re-oxidises.

Glass tube: Remove the bulb from the  
product. Using a lightly damp cloth, clean only  
the outside of the tube. Only put the bulb back  
on the product once it is fully dry.



LIT LINES  
PENDANT 2, 2011

Satin Brass.  
Pendant rod length to order.  
Limited edition of 18.

OVERALL DIMENSIONS

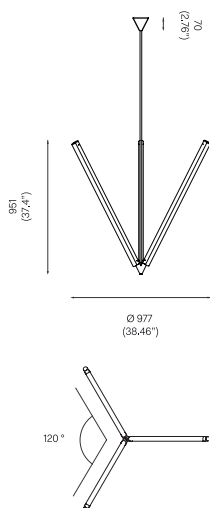

BACKPLATE DIMENSIONS

Mounting screws not included  
6mm countersunk screw recommended

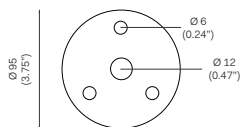

MATERIALS AND FINISHES



Satin Brass

BULB SPECIFICATIONS

Bulb specifications 120V / 240V  
S14s opal LED tube  
Radium Raledina 16.5W / 1000mm Ø 29mm  
1000lm / 2700K

PRODUCT SPECIFICATIONS

Input voltage: 120V / 240V  
Maximum wattage: 16.5W  
Dimmable: yes  
Product weight: 25kg

Pendant rod length to order with maximum  
rod length 2000mm.

Please supply required drop length of fixture,  
measured from the ceiling to bottom fitting  
at time of order.

CLEANING INSTRUCTIONS

Before cleaning, lighting fixtures must  
be turned off and unplugged from mains  
electricity. Whilst cleaning please take care  
and use the gloves provided.

Satin Brass: Use a Scotch Brite pad and gently  
rub the pad in the direction of the grain.  
Repeat until the natural patina is removed.  
On rubbing the Scotch Brite to the brass,  
grains will occur. The colour of the product  
will temporarily get lighter until it re-oxidises.

Glass tube: Remove the bulb from the  
product. Using a lightly damp cloth, clean only  
the outside of the tube. Only put the bulb back  
on the product once it is fully dry.



LIT LINES  
PENDANT 3, 2011

Satin Brass.  
Pendant rod length to order.  
Limited edition of 18.

OVERALL DIMENSIONS

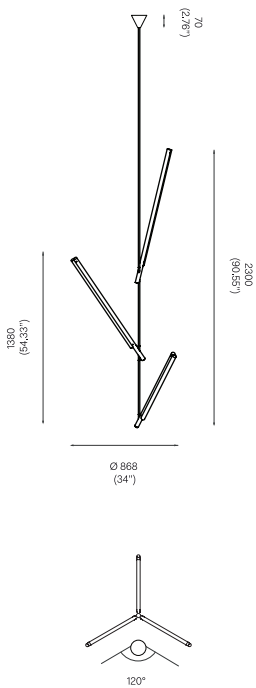

MATERIALS AND FINISHES

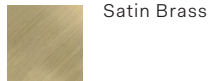

Satin Brass

BULB SPECIFICATIONS

Bulb specifications 120V / 240V  
S14s opal LED tube  
Radium Raledina 16.5W / 1000mm Ø 29mm  
1000lm / 2700K

PRODUCT SPECIFICATIONS

Input voltage: 120V / 240V  
Maximum wattage: 16.5W  
Dimmable: yes  
Product weight: 25kg

Pendant rod length to order with maximum rod length 2000mm.

Please supply required drop length of fixture, measured from the ceiling to bottom fitting at time of order.

CLEANING INSTRUCTIONS

Before cleaning, lighting fixtures must be turned off and unplugged from mains electricity. Whilst cleaning please take care and use the gloves provided.

Satin Brass: Use a Scotch Brite pad and gently rub the pad in the direction of the grain. Repeat until the natural patina is removed. On rubbing the Scotch Brite to the brass, grains will occur. The colour of the product will temporarily get lighter until it re-oxidises.

Glass tube: Remove the bulb from the product. Using a lightly damp cloth, clean only the outside of the tube. Only put the bulb back on the product once it is fully dry.

BACKPLATE DIMENSIONS

Mounting screws not included  
6mm countersunk screw recommended

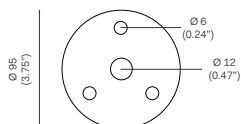



LIT LINES  
PENDANT 4, 2011

Satin Brass.  
Pendant rod length to order.  
Limited edition of 18.

OVERALL DIMENSIONS



MATERIALS AND FINISHES

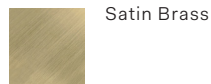

Satin Brass

BULB SPECIFICATIONS

Bulb specifications 120V / 240V  
S14s opal LED tube  
Radium Raledina 16.5W / 1000mm Ø 29mm  
1000lm / 2700K

PRODUCT SPECIFICATIONS

Input voltage: 120V / 240V  
Maximum wattage: 16.5W  
Dimmable: yes  
Product weight: 25kg

Pendant rod length to order with maximum  
rod length 2000mm.

Please supply required drop length of fixture,  
measured from the ceiling to bottom fitting  
at time of order.

CLEANING INSTRUCTIONS

Before cleaning, lighting fixtures must  
be turned off and unplugged from mains  
electricity. Whilst cleaning please take care  
and use the gloves provided.

Satin Brass: Use a Scotch Brite pad and gently  
rub the pad in the direction of the grain.  
Repeat until the natural patina is removed.  
On rubbing the Scotch Brite to the brass,  
grains will occur. The colour of the product  
will temporarily get lighter until it re-oxidises.

Glass tube: Remove the bulb from the  
product. Using a lightly damp cloth, clean only  
the outside of the tube. Only put the bulb back  
on the product once it is fully dry.

BACKPLATE DIMENSIONS

Mounting screws not included  
6mm countersunk screw recommended

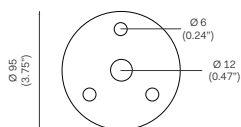



LIT LINES  
PENDANT 5, 2011

Satin Brass.  
Pendant rod length to order.  
Limited edition of 18.

OVERALL DIMENSIONS

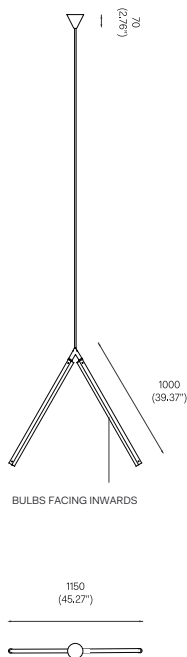

MATERIALS AND FINISHES



Satin Brass

BULB SPECIFICATIONS

Bulb specifications 120V / 240V  
S14s opal LED tube  
Radium Raledina 16.5W / 1000mm Ø 29mm  
1000lm / 2700K

PRODUCT SPECIFICATIONS

Input voltage: 120V / 240V  
Maximum wattage: 16.5W  
Dimmable: yes  
Product weight: 15kg

Pendant rod length to order with maximum  
rod length 2000mm.

Please supply required drop length of fixture,  
measured from the ceiling to bottom fitting  
at time of order.

CLEANING INSTRUCTIONS

Before cleaning, lighting fixtures must  
be turned off and unplugged from mains  
electricity. Whilst cleaning please take care  
and use the gloves provided.

Satin Brass: Use a Scotch Brite pad and gently  
rub the pad in the direction of the grain.  
Repeat until the natural patina is removed.  
On rubbing the Scotch Brite to the brass,  
grains will occur. The colour of the product  
will temporarily get lighter until it re-oxidises.

Glass tube: Remove the bulb from the  
product. Using a lightly damp cloth, clean only  
the outside of the tube. Only put the bulb back  
on the product once it is fully dry.

BACKPLATE DIMENSIONS

Mounting screws not included  
6mm countersunk screw recommended

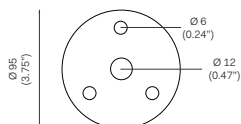



LIT LINES  
CEILING MOUNTED, 2011

Satin Brass.  
Limited edition of 18.

OVERALL DIMENSIONS

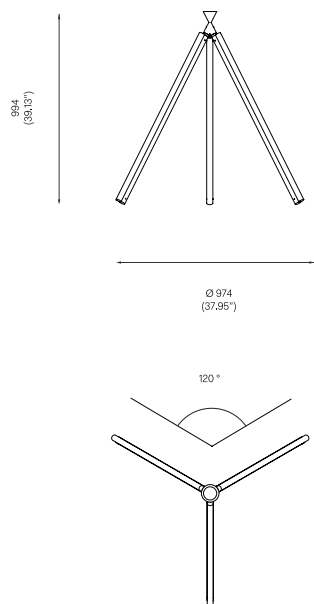

MATERIALS AND FINISHES



Satin Brass

BULB SPECIFICATIONS

Bulb specifications 120V / 240V  
S14s opal LED tube  
Radium Raledina 16.5W / 1000mm Ø 29mm  
1000lm / 2700K

PRODUCT SPECIFICATIONS

Input voltage: 120V / 240V  
Maximum wattage: 16.5W  
Dimmable: yes  
Product weight: 25kg

CLEANING INSTRUCTIONS

Before cleaning, lighting fixtures must be turned off and unplugged from mains electricity. Whilst cleaning please take care and use the gloves provided.

Satin Brass: Use a Scotch Brite pad and gently rub the pad in the direction of the grain. Repeat until the natural patina is removed. On rubbing the Scotch Brite to the brass, grains will occur. The colour of the product will temporarily get lighter until it re-oxidises.

Glass tube: Remove the bulb from the product. Using a lightly damp cloth, clean only the outside of the tube. Only put the bulb back on the product once it is fully dry.

BACKPLATE DIMENSIONS

Mounting screws not included  
6mm countersunk screw recommended

