



## ORBI

design Studio Adolini

Coffee tables available in the sizes 70x70 cm and 140x70 cm, with supporting frame in 20 mm thick MDF with beveled edges and internal dividers in 50 mm thick MDF, fully finished in Scratch-resistant Lacquered Matt Black, and rotating Ø70cm marble tabletop, screwed to a matte black lacquered steel support and connected to the supporting frame via high-sliding plastic bushings, fixed by screws and flanges.

Marble tabletop is available in marble Bianco Carrara, Nero Marquina, Rosso Levanto, Sahara Noir, Forest Green, Grigio Orobico or Deep Blue quartzite; all variants available in natural finish with a protective coating, or in glossy or matt polyester. Floor support is provided by plastic feet.

### Structure



Scratch-resistant  
Lacquered  
col. Matt Black

### Top

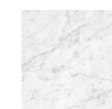

Bianco Carrara  
Marble

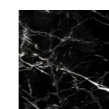

Nero Marquina  
Marble

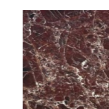

Rosso Levanto  
Marble

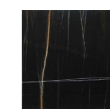

Sahara Noir  
Marble

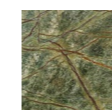

Forest Green  
Marble

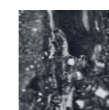

Grigio Orobico  
Marble



Deep Blue  
Quartzite

Technical Drawings

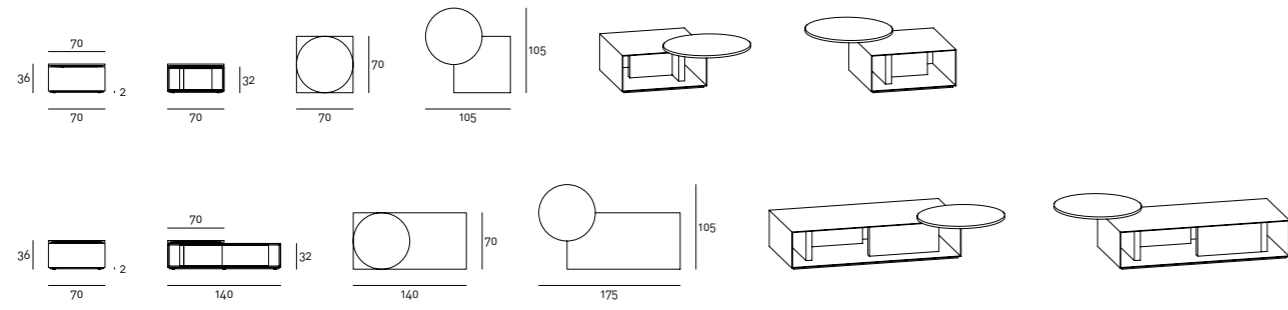

Notes

The scratch-resistant coating increases scratch resistance compared to standard coatings, but doesn't completely eliminate the possibility of scratches on the surface.

For the marble top version please specify the required finish in the order.

The natural finish with protective coating is provided as standard in a matt finish.

For marble with natural finish, the "Marble" Maintenance Kit is included with the product.

Maximum dimensions for the rotating top opening:

