



BY APPOINTMENT TO  
THE ROYAL DANISH COURT

CARL HANSEN & SØN



PRODUCT DATA SHEET

HJW37 THE PENDANT

The HJW37 The Pendant was designed by Hans J. Wegner in 1962 and has been in production ever since. The pendant features an aluminium shade with a 24-carat gold- or nickel-plated hanger and extrudes a soft, warm light ideal to illuminate a dining- or coffee table. The design comprises several functional elements such as an optional lift and height adjustable socket to adapt the height of the lamp and the light bulb for glare free lighting. Its inherent versatility makes its suitable for both the living- and dining room.

**SPECIFICATIONS**

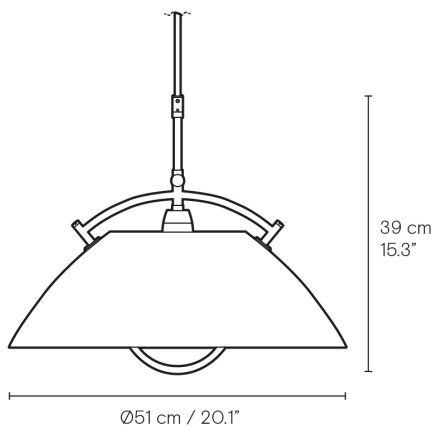

Bulb	Dimmable function	Cord	Suspension	Ceiling canopy
Not included	None	1,5m white cord for lamp w. lift 3m white cord for lamp wo. lift	Not included	A white canopy is included for lamps w. lift

Recommended light source	Socket	Max watt	Max voltage frequency	Electric shock protection	Ingress protection
Phillips LED: A60, 5W warm white	E27	16W	220-240V/50-60HZ	Class II	IP20

Packaging dimensions and weight	Height	Width	Cbm	Netto	Tara	Gross	Cartons
	420 mm	550 mm	0.13	2.0 kg	1.9 kg	3.9 kg	1/1

**Preassembled**

Yes

**MATERIALS**

Shade:  White or black painted aluminum

Hanger:  Nickel plated

Shade:  White or dark green painted aluminum

Hanger:  24 carat gold plated

RECOMMENDED LIGHT SOURCE USED FOR MEASUREMENTS

Phillips LED  
 A60 5W E27 220-240V  
 Warm white  
 4,5W = 40W  
 470 lumen  
 2700K

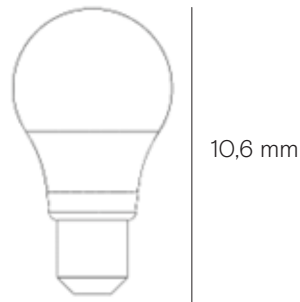

POLAR

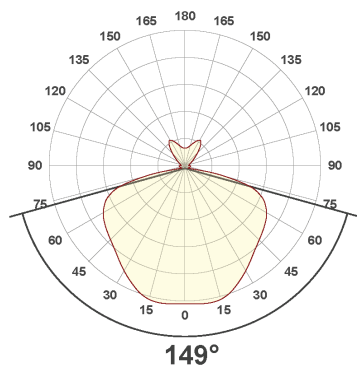

FOOTCANDLES

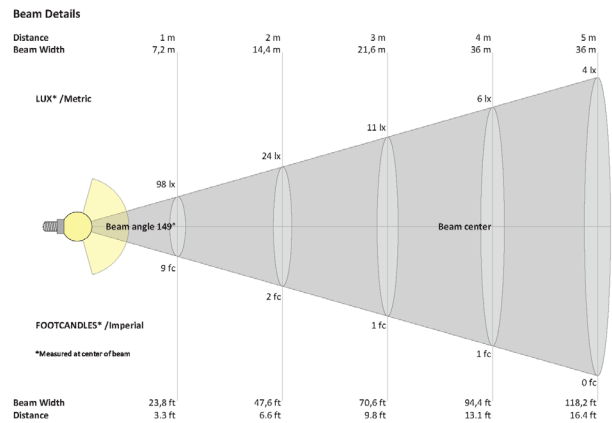

ISO-LUX

