

Flying Landscape

Piero Lissoni

2019

Divano a due o più posti, divano componibile con pouf e tavolini.



Materiali - Divano:

STRUTTURA: legno e acciaio con cinghie elastiche.

BASI: lamiera di acciaio finita con vernice acrilica color grigio effetto grezzo e piedini in materiale termoplastico color ottone. Piedini centrali e di collegamento in lamiera di acciaio finita con vernice acrilica color grigio effetto grezzo con piedino regolabile in materiale termoplastico.

IMBOTTITURA: poliuretano espanso a quote differenziate e ovatta di poliestere. Per le versioni FR (Fire Resistant) a richiesta, i materiali dell'imbottitura sono come da normative.

CUSCINO DI SEDUTA: piuma d'oca con supporto in poliuretano espanso rivestito con tela di cotone.

CUSCINO SCHIENALE: piuma d'oca mista a fibra di poliestere rivestito con tela di cotone.

RIVESTIMENTO ESTERNO: rivestimento tecnicamente sfoderabile in tessuto o fisso in pelle o velluto.

CUSCINO VOLANTE (opzionale): piuma d'oca mista a fibra di poliestere rivestito con tela di cotone.

CUSCINO POGGIATESTA: poliuretano espanso e in ovatta di poliestere, rivestito con vellutino di poliestere.

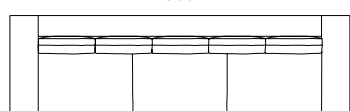
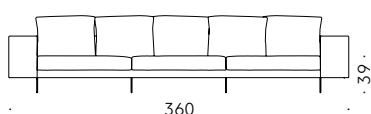
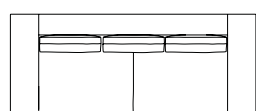
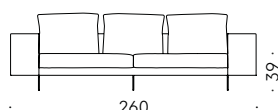
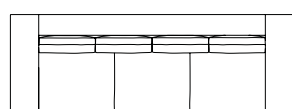
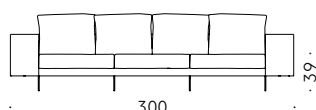
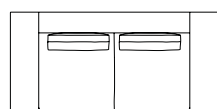
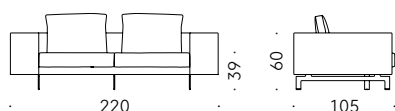

Materiali - Tavolini:

STRUTTURA: lamiera di acciaio finita con vernice acrilica color grigio effetto grezzo e piedini in materiale termoplastico color ottone.

PIANO IN LEGNO: MDF nero impiallacciato in rovere affumicato finito con vernice trasparente a base acqua o a base solvente.

PIANO IN MARMO: marmo bianco Carrara, Calacatta Oro, Grey Stone, Valentine Grey, Gris du Marais o Pietra d'Avola trattato con prodotti idrorepellenti. Rinforzo inferiore con rete di fibra di vetro annegata con resine epossidiche.

+info:
<http://www.depadova.com/materials.pdf>

Esempi di composizione

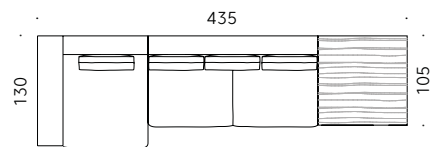
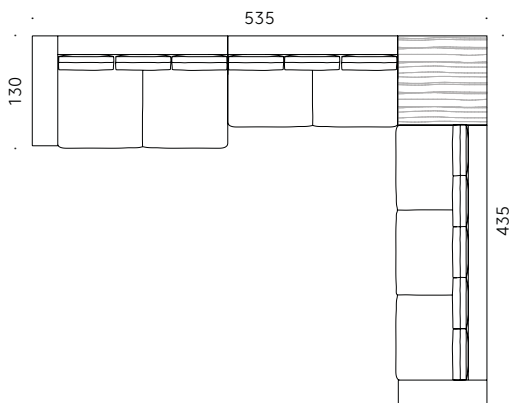
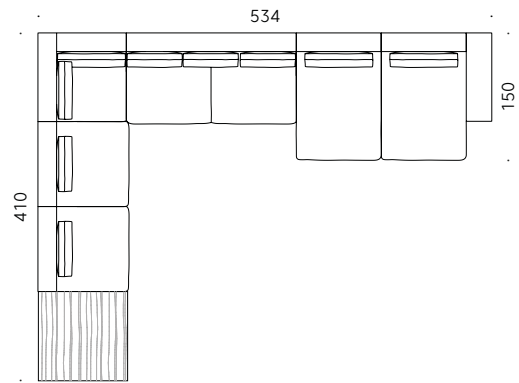
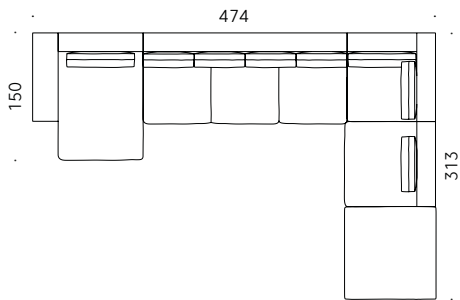

Flying Landscape

Piero Lissoni

2019

Two or more-seater sofa, modular sofa with pouf and low tables.



Materials - Sofa:

FRAME: wood and steel with elastic straps.
BASES: steel sheet finished in acrylic paint, grey raw-effect coloured, with thermoplastic feet, brass coloured. Central and connecting feet in steel sheet, finished in acrylic paint, grey raw-effect coloured with adjustable thermoplastic foot.
PADDING: variable-density polyurethane foam and polyester wadding. For FR (Fire Resistant) versions: padding materials follow current regulations.
SEAT CUSHION: goose down with polyurethane foam support, covered with cotton cloth.
BACKREST CUSHION: goose down mixed with polyester fibres, covered with cotton cloth.
EXTERNAL COVER: technically removable cover in fabric or non-removable in leather or velvet.
LOOSE CUSHION (optional): goose down mixed with polyester fibres, covered with cotton cloth.
HEADREST CUSHION: polyurethane foam and polyester wadding, covered with light polyester velvet.

Materials - Low tables:

FRAME: steel sheet finished in acrylic paint, grey raw-effect coloured and thermoplastic feet, brass coloured.
WOODEN TOP: black MDF, veneered in smoked oak, finished with transparent water-based or solvent-based coating.
TOP IN MARBLE: white Carrara marble, Calacatta Oro, Pietra d'Avola, Grey Stone, Gris du Marais or Valentine Grey, treated with water repellent products. Lower reinforcement made of fiberglass mesh, embedded in epoxy resins.

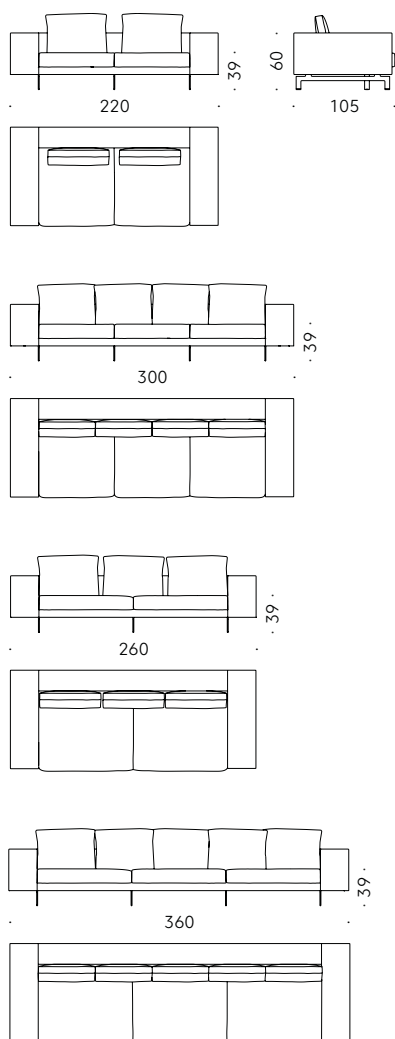

+info:
<http://www.depadova.com/materials.pdf>

Composition Examples

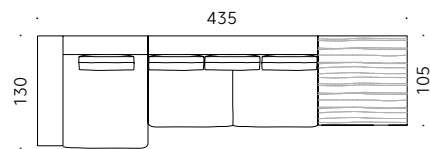
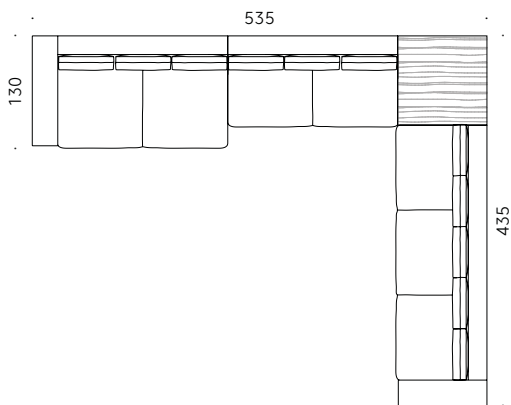
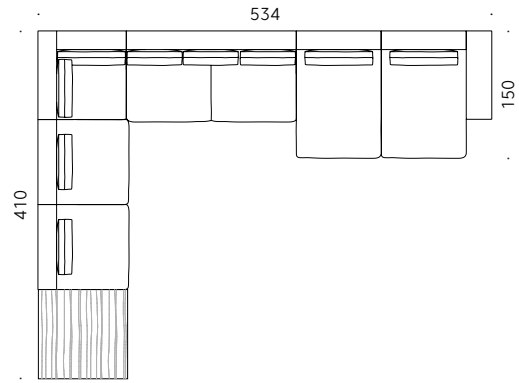
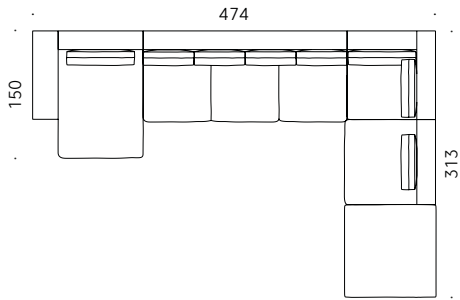

Flying Landscape

Piero Lissoni

2019

Canapé à deux places ou plus, canapé modulable avec pouf et petites tables.



Matériaux - Canapé:

STRUCTURE: bois et acier avec sangles élastiques.

BASES: tôle en acier finie avec peinture acrylique couleur gris effet brut et pieds en thermoplastique couleur laiton. Pieds centraux et de raccordement en tôle en acier finie avec peinture acrylique couleur gris effet brut avec pied réglable en thermoplastique.

REMOBOURRAGE: mousse de polyuréthane à densité variable et ouate de polyester. Pour les versions FR (Fire Resistant) sur demande, les matériaux du rembourrage sont conformes aux réglementations.

COUSSIN D'ASSISE: plume d'oie avec support en mousse de polyuréthane revêtue avec toile de coton.

COUSSIN DE DOSSIER: plume d'oie mixte à fibre de polyester avec toile de coton.

REVÊTEMENT EXTERNE: revêtement techniquement déhoussable en tissu ou fixe en cuir ou velours.

COUSSIN AMOVIBLE (option): plume d'oie mixte avec fibre de polyester avec toile de coton.

COUSSIN APPUIE-TÊTE: mousse de polyuréthane et ouate de polyester, revêtu avec velours de polyester.

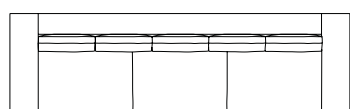
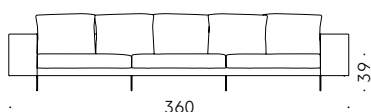
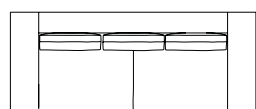
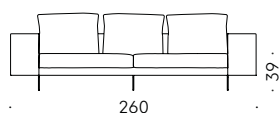
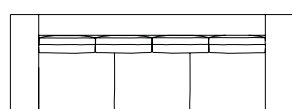
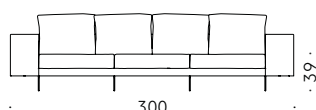
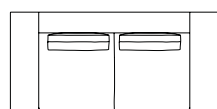
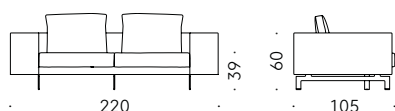

Matériaux - Petites tables:

STRUCTURE: tôle en acier finie avec peinture acrylique couleur gris effet brut et pieds en thermoplastique couleur laiton.

DESSUS EN BOIS: MDF noir plaqué en chêne fumé avec peinture transparente à l'eau ou à base de solvant.

DESSUS EN MARBRE: marbre blanc Carrara, Calacatta Oro, Grey Stone, Valentine Grey, Gris du Marais ou Pietra d'Avola traité avec des produits hydrofuges. Renfort inférieur avec grille de fibre de verre noyée avec résines époxy.

+info:
<http://www.depadova.com/materials.pdf>

Exemples de composition

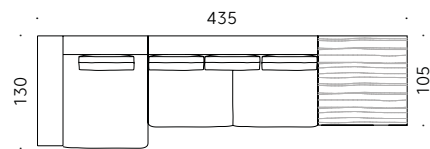
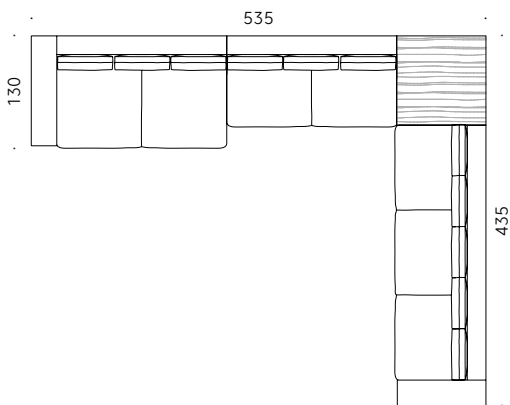
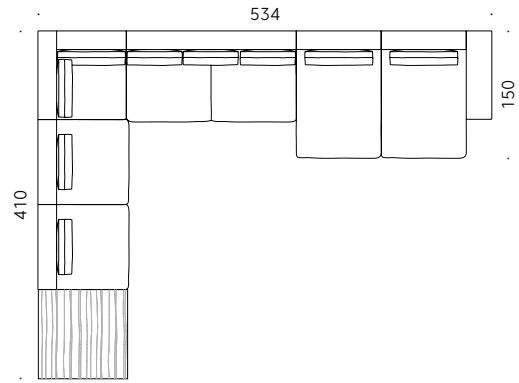

Flying Landscape

Piero Lissoni

2019

Zwei- oder mehrsitziges Sofa, modulares Sofa, Puff und Beistelltische.



Materialien - Sofa:

GESTELL: Holz und Stahl mit elastischen Gurten.

UNTERGESTELL: Stahlblech, endbehandelt mit Acryl-Lack, grau, unverarbeitet Effekt. Füße aus Thermoplast Farbton Messing. Mittige und Verbindungsfüße aus Stahlblech, endbehandelt mit Acryl-Lack, grau, unverarbeitet Effekt, mit verstellbarem Thermoplast-Fuß.

POLSTERUNG: Polyurethanschaum unterschiedlicher Dichte und Polyesterwatte. Bei den FR-Versionen (Fire Resistant) entsprechen die Polstermaterialien den geltenden Bestimmungen.

SITZKISSEN: Gänsedaunen mit Kern aus Polyurethanschaum und Überzug aus Baumwollgewebe.

RÜCKENLEHNENKISSEN: Gänsedaunen gemischt mit Polyesterfaser und Überzug aus Baumwollgewebe.

AUßENBEZUG: abnehmbarer Stoffbezug oder fester Leder-oder Samtbezug.

LOSE KISSEN (optional): Gänsedaunen gemischt mit Polyesterfaser und Überzug aus Baumwollgewebe.

NACKENROLLE: Polyurethanschaum und Polyesterwatte mit Überzug aus Polyestersamt.

Materialien - Beistelltische:

GESTELL: Stahlblech endbehandelt mit graufarbenem Acryl-Lack, der ein unbehandeltes Aussehen verleiht. Füße aus Thermoplastmaterial Farbton Messing.

TISCHPLATTE AUS HOLZ: MDF schwarz, furniert in Räumereiche, endbehandelt mit transparentem Lack auf Wasser- oder Lösemitelbasis.

TISCHPLATTE AUS MARMOR: Marmor Carrara weiß, Calacatta Oro, Valentine Grey, Grey Stone, Gris du Marais oder Pietra d'Avola, mit wasserabweisenden Produkten behandelt. Untere Verstärkung aus epoxidharzgetränktem Glasfasergewebe.

+info:

<http://www.depadova.com/materials.pdf>

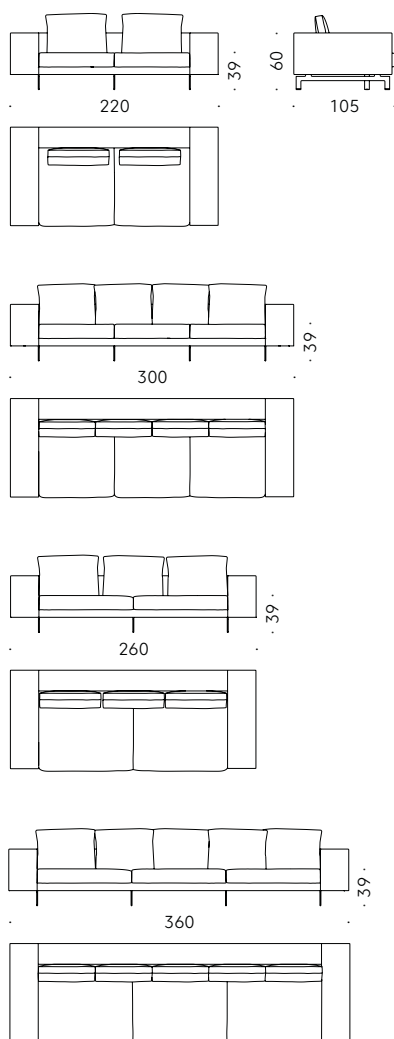

Kompositionsbeispiele

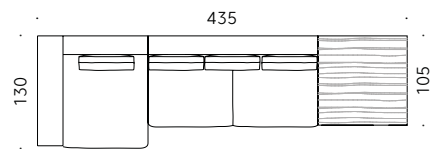
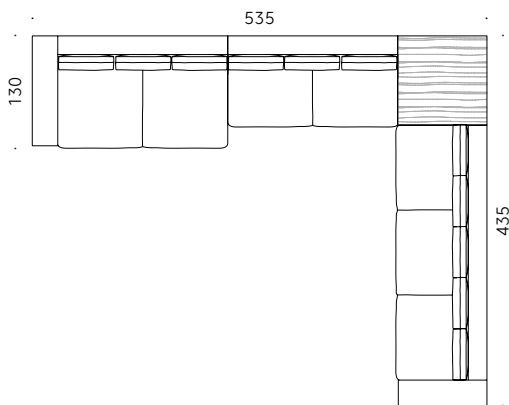
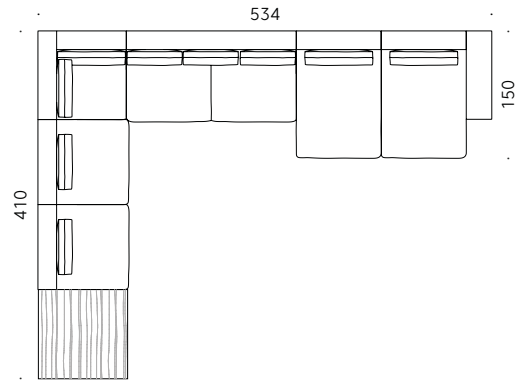

Flying Landscape

Piero Lissoni

2019

Sofá de dos o más plazas, sofá modular con puf y mesitas.



Materiales - Sofá:

ESTRUCTURA: madera y acero con cinchas elásticas.

BASES: chapa de acero acabada con pintura acrílica color gris efecto bruto y pies de material termoplástico color latón. Pies centrales y de conexión de chapa de acero acabada con pintura acrílica color gris efecto bruto con pie ajustable de material termoplástico.

RELLENO: espuma de poliuretano de densidad diferente y guata de poliéster. Para las versiones FR (Fire Resistant) bajo pedido, los materiales del relleno cumplen con las normativas.

COJÍN DE ASIENTO: plumas de oca con soporte de espuma de poliuretano revestida con tela de algodón.

COJÍN RESPALDO: plumas de oca mixtas con fibra de poliéster revestido con tela de algodón.

TAPIZADO EXTERIOR: tapizado técnicamente desenfundable de tejido o fijo de piel o terciopelo.

COJÍN SUELTO (opcionales): plumas de oca mixtas con fibra de poliéster revestido con tela de algodón.

COJÍN REPOSACABEZAS: espuma de poliuretano y guata de poliéster, revestida de terciopelo de poliéster.

Materiales - Mesitas:

ESTRUCTURA: chapa de acero acabada con pintura acrílica color gris efecto bruto y pies de material termoplástico color latón.

TABLERO DE MADERA: MDF negro chapado de roble ahumado acabado con barniz transparente al agua o al disolvente.

TABLERO DE MÁRMOL: mármol blanco Carrara, Calacatta Oro, Grey Stone, Valentine Grey, Gris du Marais o Pietra d'Avola tratado con productos repelentes al agua. Refuerzo inferior con red de fibra de vidrio ahogada con resinas epoxídicas.

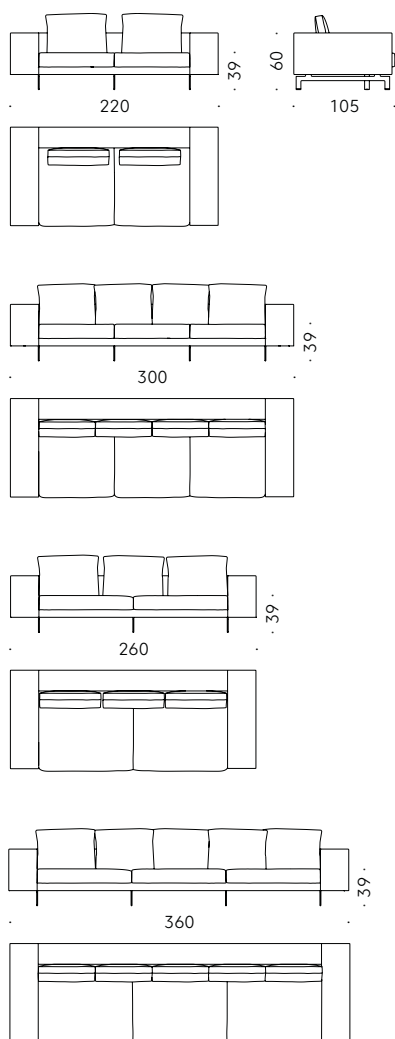

+info:

<http://www.depadova.com/materials.pdf>

Ejemplos de composición

